

KLIP-BILT

SPEEDI-BILT

QUICK-BILT

HD DRAWERS



**COMPLETE ASSEMBLY
GUIDE OCT. 2016**

**INDUSTRIAL SHELVING - BOLTLESS SHELVING
AUTO BINS - UNDERCOUNTER UNITS - HD SHELVING UNITS**

TABLE OF CONTENTS

Klip-BILT II	2
Plan View of Layouts	3
Uprights	3
Open Type Units	3
Closed Type Units	4
Shelves	5
Unit Completion	6
Open Type Units	6
Closed Type Units	6
Accessories	8
Speedi-BILT	10
Uprights	11
Additional Beams and Features	12
Shelf Surfaces	12
Basic Connection Details	12
Beam and Support Arrangements	13
Quick-BILT	14
Base and Top Shelves	15
Back Panels	15
Unit Completion	16
Accessories	17
HD Drawers 3' - 4"	18
Side and Back Panels	19
Drawer Glides	19
Drawers	21
Unit Completion	22
HD Drawers 7' - 1", 8' - 1"	23
Side and Back Panels	24
Drawer Glides	24
Drawers	26
Unit Completion	27

KLIP-BILT II®

ASSEMBLY INSTRUCTIONS

IMPORTANT

CHECK MATERIAL RECEIVED I.E. NUMBER OF PACKAGES AND CONTENTS OF EACH PACKAGE.
PLACE MATERIAL NEAR AREA TO BE INSTALLED.
READ ASSEMBLY INSTRUCTIONS BEFORE STARTING.

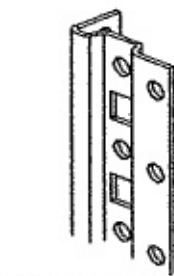
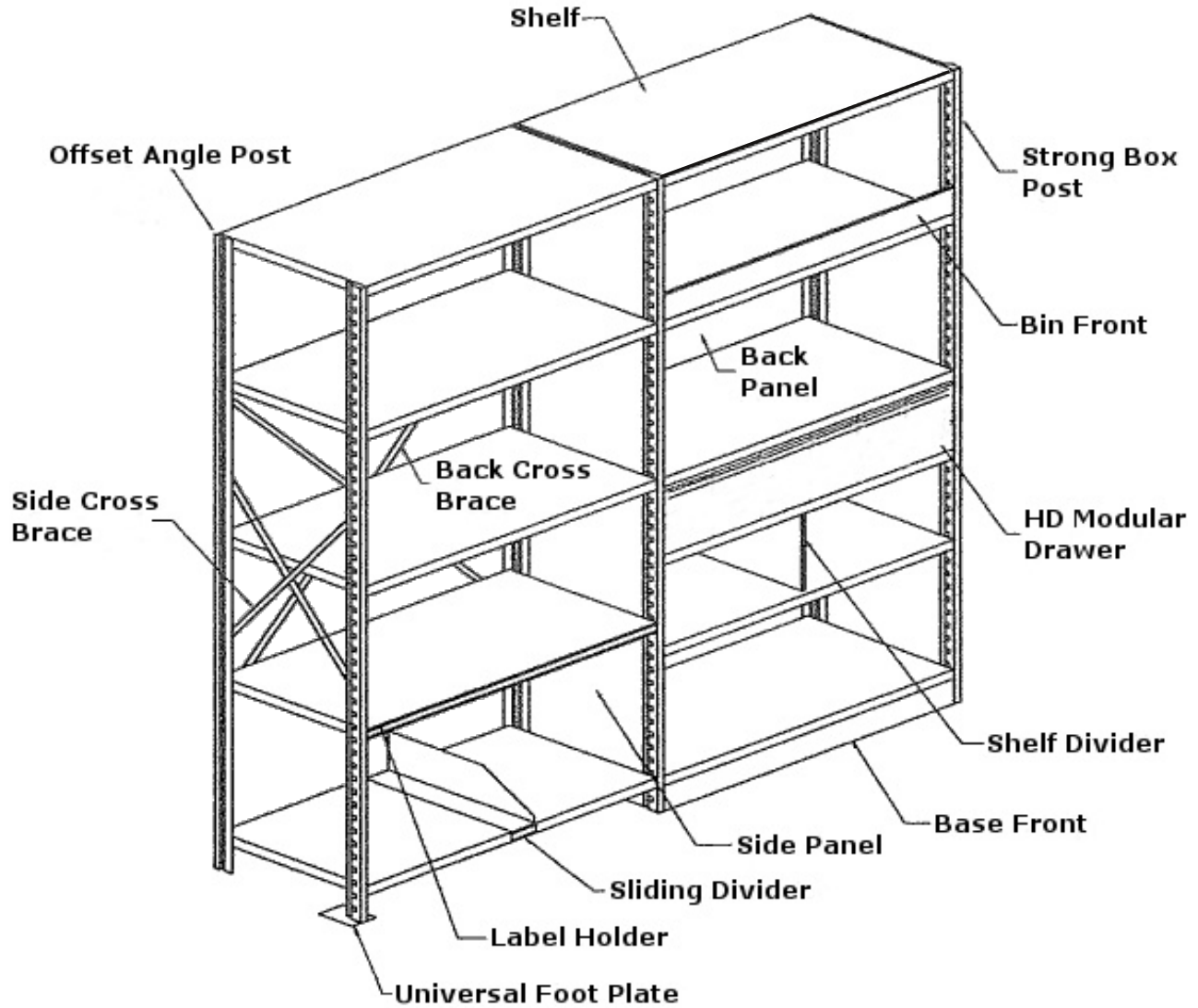

Offset Angle Post

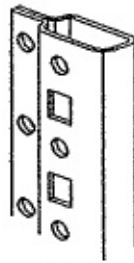

Strong Box Post

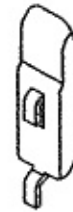

Lickety-Klip

KLIP-BILT II®

The basic Klip-BILT II shelving unit consists of two front posts, two rear posts, hardware, and as many intermediate shelves as the customer desires. Open type units employ back and side cross braces, while closed type units require back and side panels. Other accessories can be added to meet unique requirements.

Front and rear posts can either be offset angle posts or strong box posts. Both of these post types can be connected to side pannels/cross braces to form side uprights. Depending on location, the upright may serve in a row end or intermediate capacity. The units can be arranged as individual units, side-by-side single row units, or side-by-side and back-to-back double row units. Refer to Figures 1-3 for a visual representation of these layouts.

1) Determine Post Arrangement, Unit Type, and Unit Layout

Based on the parts provided and customer's desired floor plan, use the figures below to identify which unit design meets the criteria.

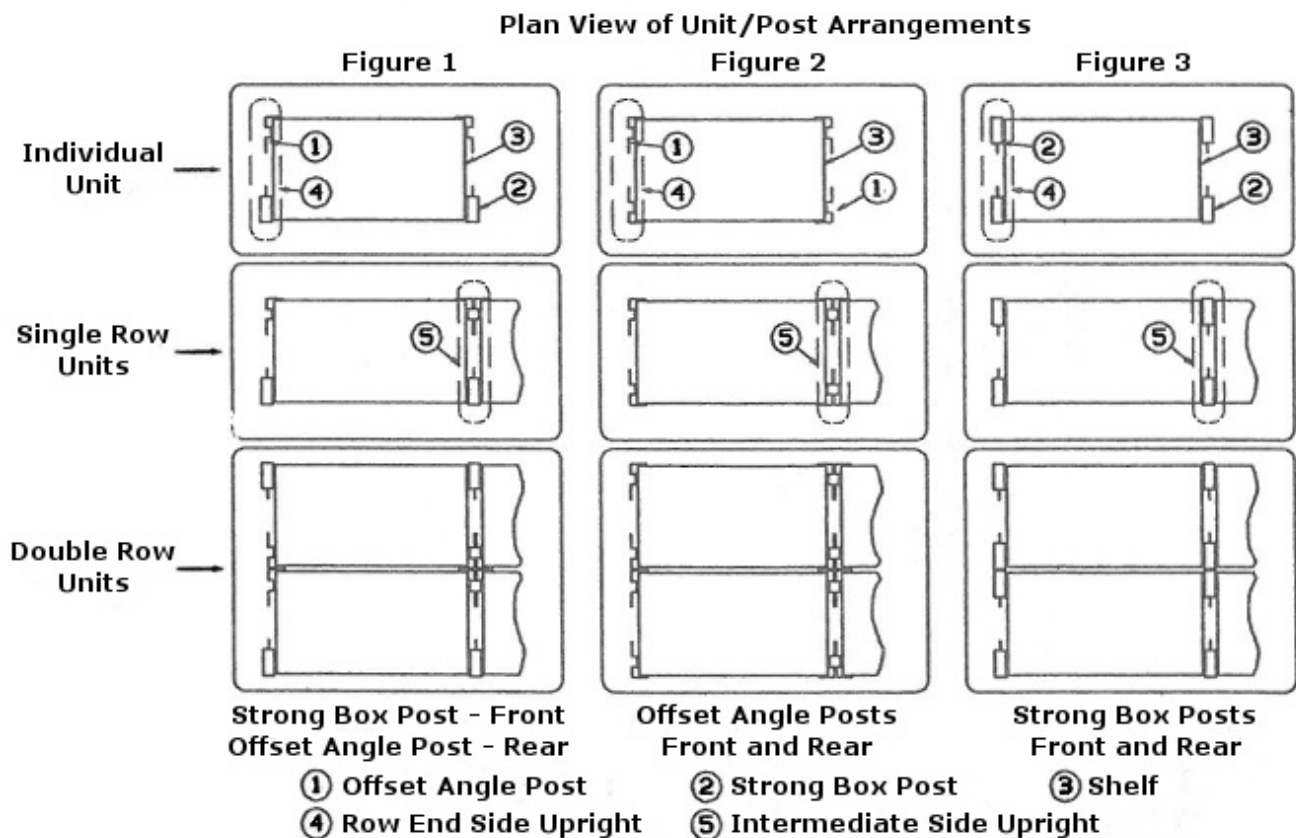

2A) Assemble Uprights for Open Type Units

Gather the quantity of row end and intermediate side uprights that suits the desired unit arrangement. Individual units require just two row end side uprights. For a sequence of single row units, use two row end side uprights and a number of intermediate side uprights. This number will always be one fewer than the total number of units in the row. Double row units require four row end side uprights and two fewer intermediate side uprights than the total number of units in the rows.

2A Continued On Following Page

KLIP-BILT II®

Ahering to Step 1, position the requisite type and quantity of front/rear posts parallel to each other on a suitable work surface. Space the posts such that the distance between the outside edges equals the nominal unit depth plus 3/16". Bolt a pair of side cross braces together at their midpoint with one 1/4" by 1/2" bolt and nut. Finger tighten only.

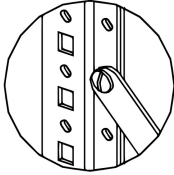

Figure 4
Strong Box
Post

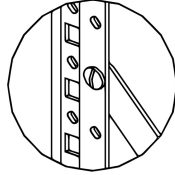

Figure 5
Single Offset
Angle Post

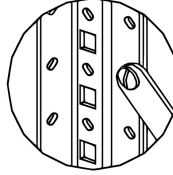
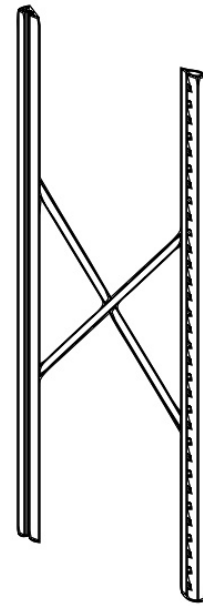

Figure 6
Double Offset
Angle Post



2B) Assemble Uprights for Closed Type Units

Follow Steps 1 and 2A up until you have the appropriate quantity of front posts, rear posts, and side panels arranged on a suitable work surface. Align the holes of a side panel with the holes in the edge flange of two posts. At this point the side panel's edges should be positioned between the flanges of strong box and double offset angle posts and/or toward the inside of single offset angle posts. Refer to Figures 7-11 to better understand these orientations.

Bolt the side panel to the front and rear posts with 1/4" by 1/2" bolts and nuts. For units less than or equal to 8' 1" in height, use five bolts on the front post and five on the rear. Units over 8' 1" require one or more additional bolts on each post. Bolts and nuts should be attached at the third hole in from each end of the posts. The remainder should then be evenly spaced between these points.

Note: Special applications (e.g. seismic codes or units higher than 10' 1") may necessitate additional bolts and nuts. If this is the case, bolt panels per separate instructions or based on the material ordered.



Figure 7

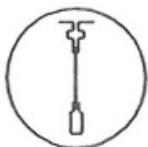

Figure 8

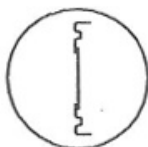

Figure 9

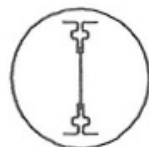

Figure 10

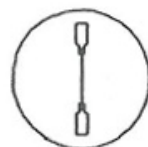
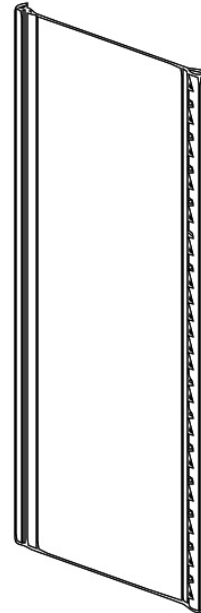

Figure 11



KLIP-BILT II®

3A) Install Box Shelves

Install one Lickety-Klip at the required shelf location in the front and rear posts on both sides of the unit. Each individual shelf rests on four clips. Shelf clips are installed by inserting the tabs into two square holes in the post and lowering the clip until it's seated in the holes as shown in Figure 12.

Position each corner of the shelf over a shelf clip and lower it onto them. Seat the shelf by tapping the corners down until each is well-supported by an individual clip. Refer to Figure 13 for a representation.

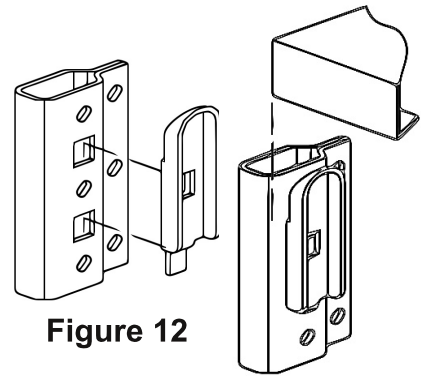

Figure 12

Figure 13

3B) Install Shelves with Gusset Braces

Gusset braces can be used in certain limited conditions where double entry shelving units are desired. Shelf clips, back panels, and cross braces are not used in these instances. Instead, each shelf requires just one brace at each corner. Normally only certain shelves in a unit require gusset braces. The remainder will be installed according to the previous steps. Gusset braces **must** be deployed in the quantity and arrangement specified by Bilt.

For units with strong box posts, bolt each shelf corner to a post at the desired location. Connect them with 1/4" by 1-1/4" bolts and nuts at the oval hole in the shelf's side flanges and the mating holes in the posts' side flanges. The bolt will be common to both shelves in adjoining units if they are at the same level.

Each brace will then be bolted to the face flange of the shelf using two #14 by 1/2" hex washer heads. Bolt the vertical flange of each brace to the post with two 1/4" by 1-1/4" bolts and nuts. If shelves in adjoining units are at the same level, these bolts are common to **both braces**. Finger tighten only. Refer to Figure 14.

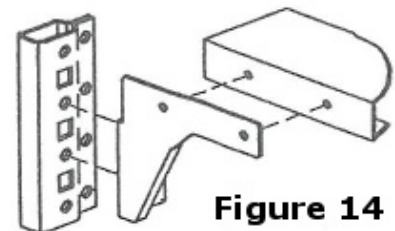

Figure 14

For units with offset angle posts, bolt each gusset brace to the face flange of a shelf using two #14 by 1/2" hex washer heads. Position each brace on the inside of a post flange, then bolt the shelf's corners to the post at the desired location. Connect them with 1/4" by 1-1/4" bolts and nuts at the oval hole in the shelf's side flanges and the mating holes in the posts' side flanges.

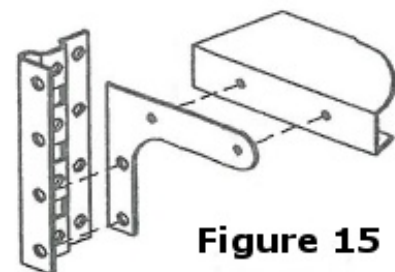

Figure 15

Bolt the vertical leg of each brace to the posts with two 1/4" by 1/2" bolts and nuts. Finger tighten only. Refer to Figure 15 for guidance.

KLIP-BILT II®

4A) Complete Open Type Units - Individual or Single Row Arrangement

Place one row end side upright and the next required side upright on end in the desired location. Install the top and bottom shelves adhering to Step 3, then install back cross braces on every unit. Special applications such as seismic, high-rise, and mezzanine units will require additional back bracing. In such instances install back cross braces based on the material ordered or separate instructions.

Units with rear strong box posts use universal back cross braces composed of one right and one left hand brace. Orient the braces with the end flanges toward the inside of the unit. Bolt the braces together at their midpoints with one 1/4" by 1/2" bolt and nut. Finger tighten only. Position the braces on the posts with the midpoint at or slightly above the midpoint of the unit's height. Bolt all four ends of the braces to the posts' side flanges with 1/4" by 1-1/4" bolts and nuts. Finger tighten only. Figure 16 depicts this step.

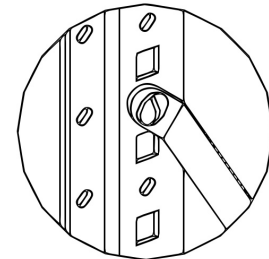

Figure 16

For units with rear offset angle posts, the back braces are simply flat back cross braces. Follow the previous paragraph's procedure for assembling and positioning the cross brace. Bolt all four ends of the braces to the posts' rear flanges with 1/4" by 1/2" bolts and nuts. Finger tighten only. See Figure 17 for assistance.

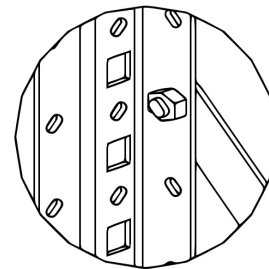

Figure 17

Situate the unit so that it is plumb and level, then tighten all bolts and nuts. Shimming may be necessary if the floor is uneven. For single row units only, continue adding side uprights, top and bottom shelves, and, where required, back cross braces. Repeat the entire process until all units and/or rows are completed. Finish by installing all required accessories and intermediate shelves. Refer to Step 3 and the accessories section, respectively, for further instruction.

4B) Complete Closed Type Units - Individual or Single Row Arrangement

Follow the procedure outlined in the first paragraph of 4A to connect side uprights. Begin installing a back panel by sliding one of its edges between a shelf and the inside flange of an offset angle post. Once it clears the opposite post's flange, do the same with the inside of this flange and the shelf. Align the holes in the back panel with the holes in the posts. Insert a drift pin through one of the center holes, then raise the panel until the highest center hole lines up with the one in the top shelf.

Bolt the back panel to both offset angle posts with 1/4" by 1/2" bolts and nuts. For units 8'-1" and under, always use five bolts and nuts on each post. Locate bolts and nuts approximately 6" from each end of the posts, and space the remainder equally along the length of the posts. Finger tighten only.

4B Continued On Following Page

KLIP-BILT II®

Units higher than 10'-1" or designed for certain special applications, like seismic codes, may require additional bolts and nuts. In such cases bolt panels per material ordered or separate instructions.

Position the unit so that it is plumb and level. Tighten all bolts and nuts, then check to see if shimming is needed. Continue adding side uprights, top and bottom shelves, and back panels for single row units. Repeat the procedure until all units and/or rows are complete. Install intermediate shelves at the desired locations and accessories as required.

4C) Complete Closed Type Units - Double Row Arrangement

Assemble the front row according to Step 4C, but position the back panel on the outside of the offset angle post flanges.

Place the front and rear row back-to-back. Using a drift pin, align the holes in the rear flanges of the offset angle posts with the holes in the back panel. Bolt through both posts and the back panel using 1/4" by 1/2" bolts and nuts. Employ the same quantity and placement described in the second paragraph of Step 4C. Install intermediate shelves and accessories.

Accessories On Following Page

Accessories

Sliding Divider

Snap a sliding divider over the front of intermediate or base shelves. Fit the rear flange over the shelf's own to secure the divider. Slide across the top of the shelf to reposition.

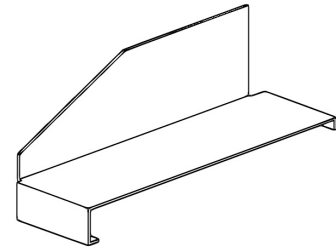

36 or 48" Label Holder

Align the holes in a label holder with those in the face of a box shelf. Using plastic push-in fasteners, attach the label holder in three places for intermediate shelves and two for base shelves.

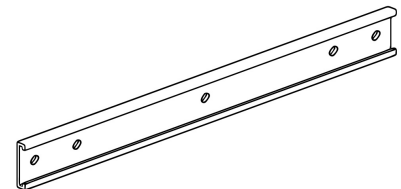

Note: Sliding dividers and 36/48" label holders cannot be used in conjunction with one another.

Universal Footplate

Slide a footplate under a post in the desired orientation, then bolt it through the hole in its vertical tab using 1/4" bolts and nuts. When bolted to any of a post's flanges, a 3/4" bolt is used. Secure the footplate with a suitable 3/8" diameter anchor if necessary.

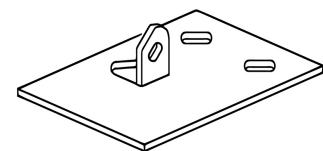

Bin Front

Set a bin front at the front edge of a shelf in the same position as the illustration. Bolt it to the side flanges of the adjacent posts using two 1/4" by 1-1/4" bolts and nuts at **each** end. Bolts will be common to pairs of bin fronts in the event that they are in adjoining units and at the same level.

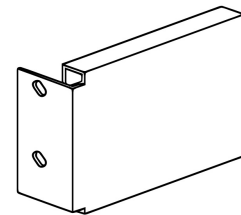

Base Front

Place a base front on the floor underneath the front edge of a bottom shelf. It should fit readily in front of the shelf clips and between the side flanges of the posts. The base front is held in place by its vertical tabs and the weight of the bottom shelf resting on its sloped flange.

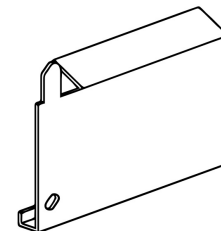

Accessories Continued On Following Page

Shelf Divider

Position the divider at the desired location on top of the shelf. Orient it with the larger corner notches to the rear of the unit. Attach the divider to the shelf via the top and bottom flanges using dart clips. If two dividers are located directly above one another in a single unit, the top clips are common to both dividers.

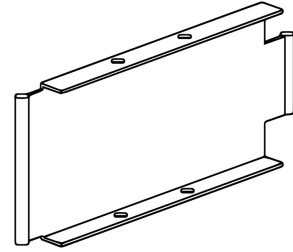

Post Splices

In certain situations, post splices may be used to extend the height of posts. Extremely careful consideration must be used in these instances to ensure a safe installation. Contact Bilt before initiating all splicing applications.

SPEEDI-BILT®

ASSEMBLY INSTRUCTIONS

IMPORTANT

CHECK MATERIAL RECEIVED I.E. NUMBER OF PACKAGES AND CONTENTS OF EACH PACKAGE.
PLACE MATERIAL NEAR AREA TO BE INSTALLED.
READ ASSEMBLY INSTRUCTIONS BEFORE STARTING.

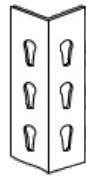

Angle Post
(Standard & Heavy Duty)



Tee Post

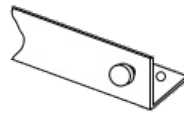

Single Rivet Beam

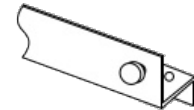

Single Rivet Beam
Heavy Duty

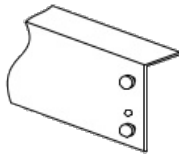

Double Rivet Beam

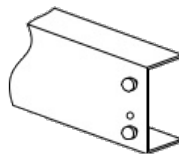

Double Rivet Channel
(Standard & Heavy Duty)

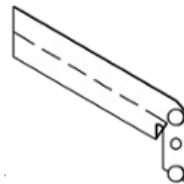

Low Profile
Double Rivet Beam

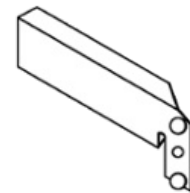

Low Profile
Double Rivet Channel

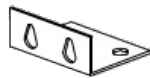

Universal Foot Plate

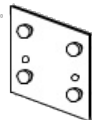

Tie Plate

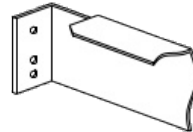

Support Tie (Holes Both Ends)
Wall Tie (Rivets One End)
Double Tie (Rivets Both Ends)

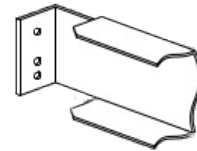

Support Tie
Heavy Duty

WARNING

Speedi-BILT units are intended for use in hand-loaded applications only.
Powered material-handling equipment should **never** be used around Speedi-BILT
units without Bilt's explicit approval.

SPEEDI-BILT®

The basic Speedi-BILT shelving unit consists of four angle posts, two top beams, two bottom beams, and as many intermediate shelves/side beams necessary to meet the customer's specifications. Multiple units in a row require angle posts at the row ends and either double angle posts or tee posts at the intermediate upright locations. **Double angle posts are connected using tie plates.**

Beam type and location, as well as support tie/shelf support quantity and location, vary to suit loading demands. Ensure that the proper configuration is installed to provide the desired load-carrying capacity.

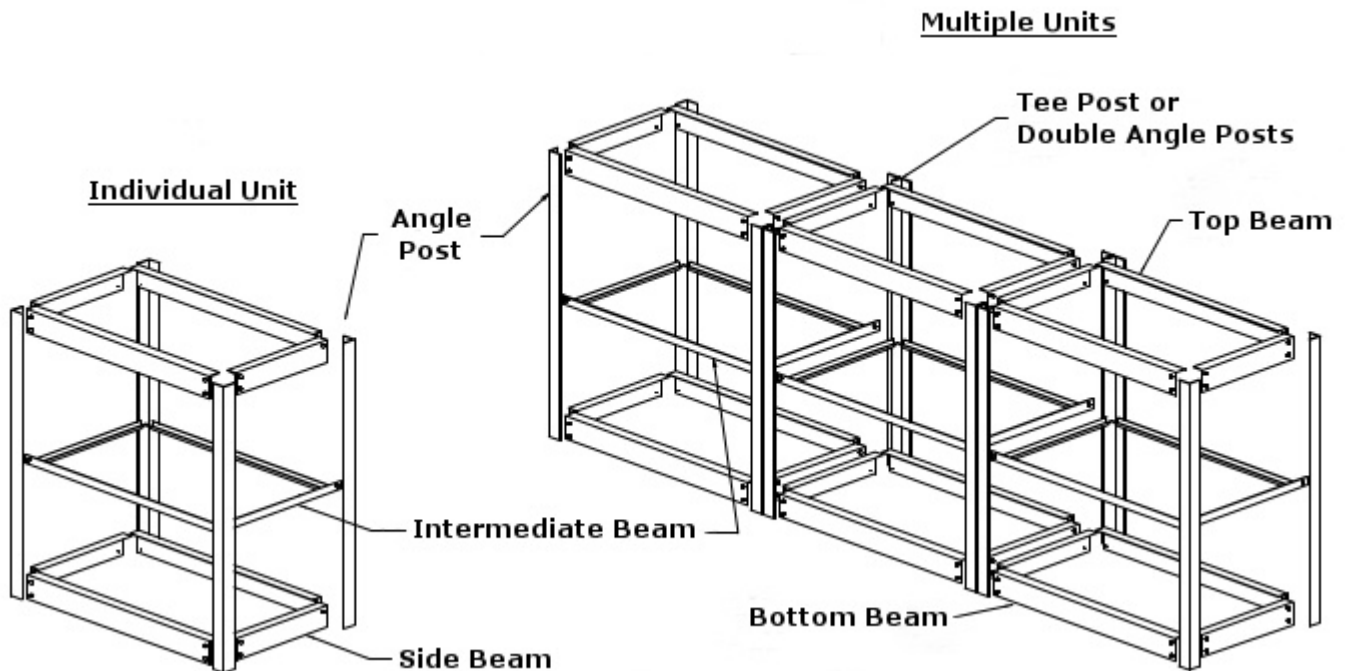

1) Assemble Initial Row End Upright

Construct a row end upright by laying two angle posts on the floor with the keyhole slots pointing in the same direction. Install the appropriate beams using two rivets at the top and bottom of both posts.

2A) Assemble Final Row End Upright for Individual Unit

Repeat step one, then lay the two uprights on edge. Install the proper beams using two rivets at the top and bottom of both posts. Turn the unit over and repeat for the other side. Verify that all beams are oriented properly and fully seated.

2B) Assemble Intermediate and Final Row End Uprights for Multiple Units

Create an intermediate upright by substituting either double angle posts or tee posts into step one. If intermediate shelves have just front and rear beams, the double rivet side beams are only required on one of the intermediate upright's sides. Build as many intermediate uprights as instructed.

2B Continued On Following Page

Stand the uprights vertically. Install the proper front and rear beams at the top and bottom of each pair of uprights until all intermediate units are complete. Repeat step one, then finish the row using this final row end upright. Verify that all beams are oriented properly and fully seated.

3) Install Intermediate Beams and Additional Features

Install any intermediate beams, support ties, shelf supports, foot plates, and other accessories as needed/requested. Verify that beams are situated at the desired locations, oriented properly, and fully seated.

4) Install All Shelf Surfaces

These, which may or may not be furnished by Bilt, are generally composed of steel, particle board, or wire mesh. The size of the shelf surface should equal the nominal unit size width and depth. Space limitations for atypical projects may require completion of this step as each row of shelves, instead of units, is assembled.

Refer to Basic Connection Details below for further instruction.

Beam to Post (Including Rivet Tab Hang Rod)

a) Align the rivets of a beam or rivet tab hang rod with the enlarged end of the slots in a post.

b) To start the rivet shoulder into the narrow portion of the post slots, push the rivet heads through the post's slots and downward.

c) Using a rawhide or rubber mallet, tap the top edge of the beam until all rivets are fully seated in slots. Beams must be oriented as shown on previous page.

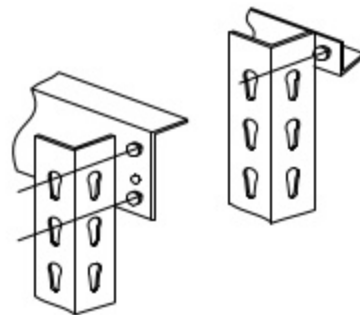

Support Tie to Double Rivet or Channel Beam

a) Align the holes in the end of a support tie with the holes in the face of a beam. Attach each end with two 10-24 by 1/2" bolts and nuts.

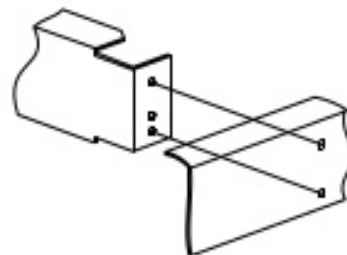

Tie Plate to Post

a) Align the rivets in a tie plate with the slots in the adjoining posts. Assemble based on the same instructions as those for beam to post connections.

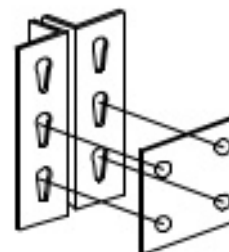

Continued On Following Page

Foot Plate to Post

a) Universal foot plates are used with single angle posts, double angle posts, and tee posts. Position a foot plate under the bottom of a two post(s). The enlarged portion of the keyhole slot should clear the rivet head in the bottom beam.

b) Attach the foot plate to the post(s) by inserting a 5/16-18 by 1/2" screw through the smaller portion of the keyhole slot in both. Anchor them through the corresponding hole in the bottom beam. Install a 5/16-18 nut from the back side and tighten. Single angle posts require one bolt and nut; double angle posts/tee posts require two of each.

c) If required, bolt the foot plate to the floor with a 5/16 flat washer.

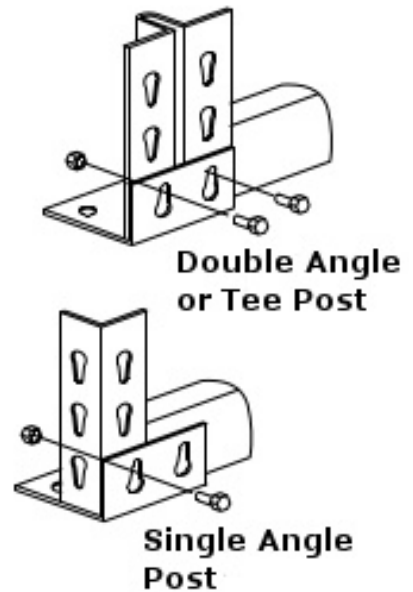

Shelf Beam and Shelf Support Arrangement



**Single Rivet Beam
Front and Rear
(Intermediate Shelf Only)**

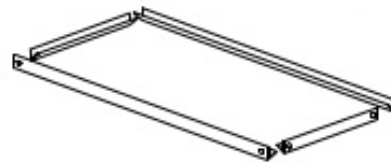

**Single Rivet Beam
Four Sides
(Intermediate Shelf Only)**

**Optional Support
Tie (Typ)**

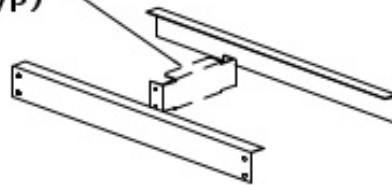

**Double Rivet or Channel Beam
Front and Rear
(Intermediate Shelf Only)**

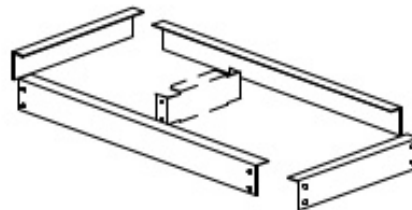

**Double Rivet or Channel Beam
Four Sides**

QUICK-BILT®

ASSEMBLY INSTRUCTIONS

IMPORTANT

CHECK MATERIAL RECEIVED I.E. NUMBER OF PACKAGES AND CONTENTS OF EACH PACKAGE.
PLACE MATERIAL NEAR AREA TO BE INSTALLED.
READ ASSEMBLY INSTRUCTIONS BEFORE STARTING.

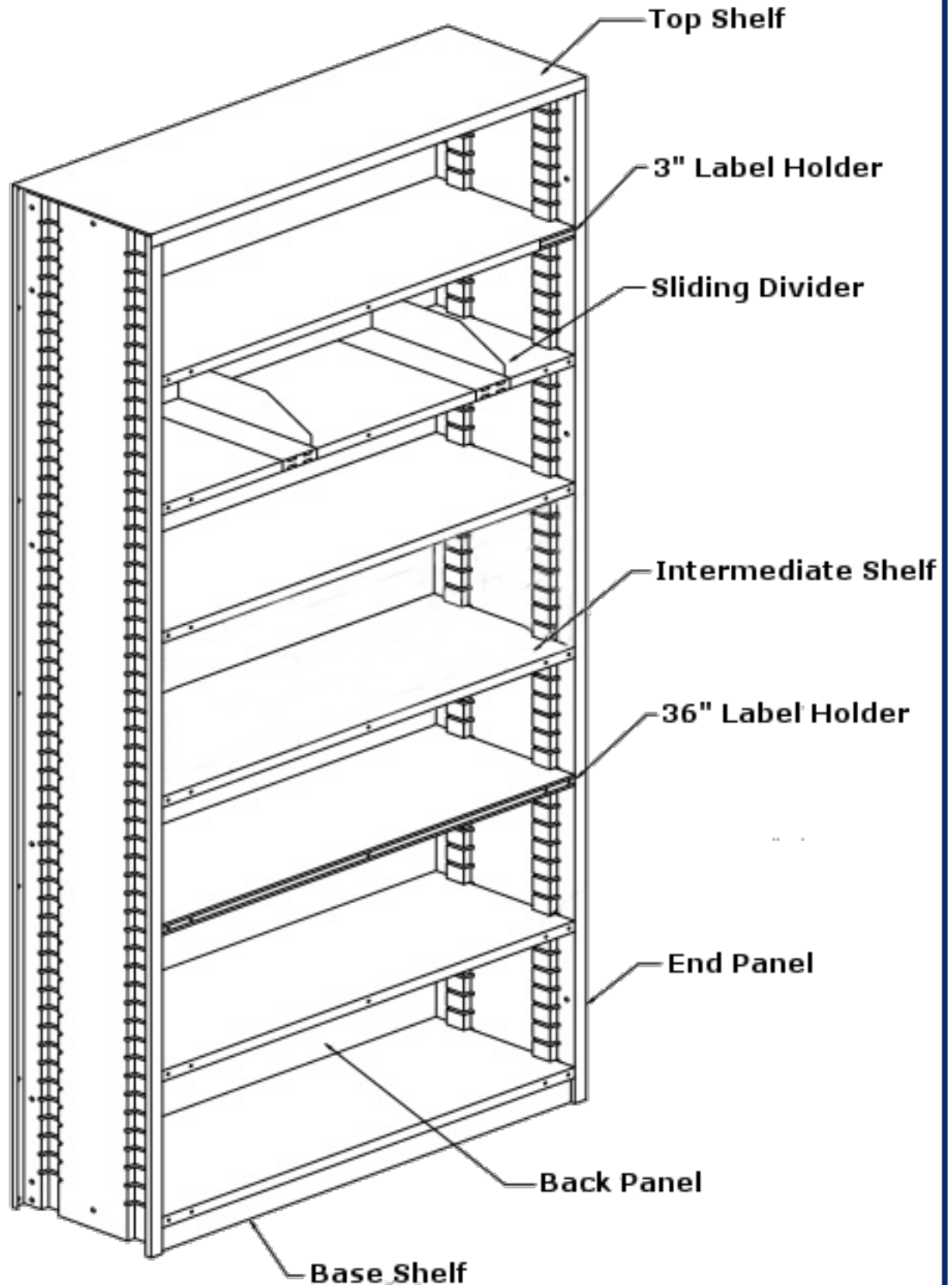

QUICK-BILT®

The basic Quick-BILT shelving unit consists of two end panels, one base shelf, one top shelf or mezzanine support platform, one back panel, and as many intermediate shelves as the customer desires. Other accessories can be added to meet unique requirements.

It is recommended that the unit lie face down on the floor during steps one through four of the assembly process. Figures one through four have been illustrated accordingly.

1) Assemble Base Shelf

Set an end panel on the floor as represented in Figure 1. When placed in this manner, the rear face flange (the one with holes) is positioned up, the slotted offset flanges toward the inside of the unit, and the bottom of the end panel as shown.

Align the base shelf with the end panel as depicted in Figure 1. Slide the top surface of the shelf into the bottom set of slots in the offset flanges, then bolt it to the end panel in three locations using 1/4 by 1/2" bolts and nuts. Finger tighten only. Repeat the procedure for the other end of the base shelf using another end panel.

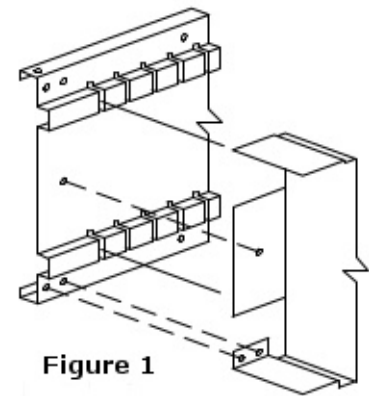

Figure 1

2A) Assemble Standard Top Shelf

Orient a top shelf with its face flange positioned down as shown in Figure 2. Place the top shelf's front and rear flanges on the outside of the end panel. Once the shelf is properly aligned, bolt the flange faces and attaching tabs using 1/4 by 1/2" bolts and nuts. Finger tighten only. Repeat the procedure for the other end of the top shelf using another end panel.

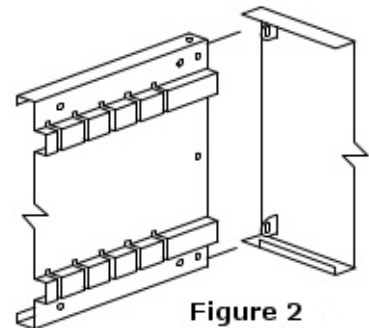

Figure 2

3A) Assemble Back Panel to Single Row Units

Identify the bottom edge of a back panel by observing the edge with two holes located 1" from its side. Place the back panel on top of the end panels, base shelf, and top shelf/platform so that, as depicted in Figure 3, the bottom edge rests on the lowest part of the end panels.

With the unit remaining face down, bolt the back panel to both end panels and the base shelf using 1/4 by 1/2" bolts and nuts. Finger tighten only. Stand the unit upright and bolt the back panel to the top shelf in both places using 1/4 by 1/2" bolts and nuts. Finger tighten only.

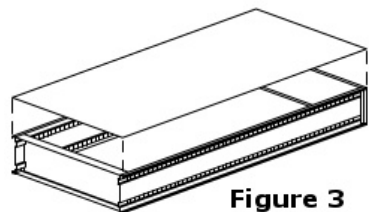

Figure 3

3B) Assemble Back Panel to Double Row Units

Construct two distinct units following steps one and two. Stand the units upright, then position them back-to-back. Identify the bottom edge of a back panel by observing which has two holes located 1" from it. With the back panel in an upright position, situate this edge nearest the floor and slide the panel between the units. Bolt it to both end panels using 1/4 by 1/2" bolts and nuts. Finger tighten only. It is not necessary to bolt the back panel to the base shelf or top shelf/platform for double row units.

4) Plumb Unit and Tighten Bolts/Nuts

Orient each shelf perpendicular to the back panel; in this position the five-hole flange should be at the front of the unit. Taking care to verify that the shelf's lances interlock with the offset flanges, slide the edges into the slots of the end panels as shown Figure 4. Install the desired number of intermediate shelves at the heights specified by the customer.

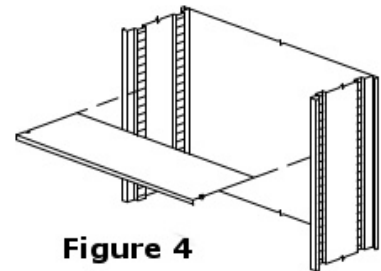

Figure 4

To reposition a shelf, simply raise the front up, dislodge it from the slots, and repeat the installation steps. Tighten all bolts and nuts once the unit is plumb and level.

5) Complete the Assembly

Repeat steps one through four until all units have been erected and meet the customer's requirements.

Locate the holes near the front offset flanges on each unit's end panels. Reinforce **all** adjacent units by bolting together their panels using 1/4 by 2-1/2" bolts and nuts. Non-mezzanine applications only need to be bolted twice on each side; mezzanine applications must be bolted in all eight places.

Accessories

Sliding Divider

Snap a sliding divider over the front of intermediate or base shelves. Fit the rear flange over the shelf's own to secure the divider. Slide across the top of the shelf to reposition.

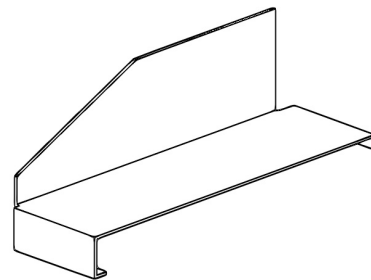

36 or 48" Label Holder

Align the holes in a label holder with those in the face of an intermediate or a base shelf. Using plastic push-in fasteners, attach the label holder in three places for intermediate shelves and two for base shelves.

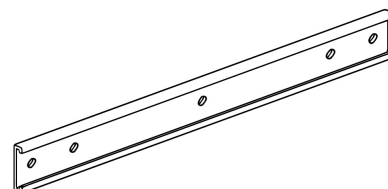

3" Label Holder

Attach a magnetic label holder to any section of a shelf that the customer specifies.

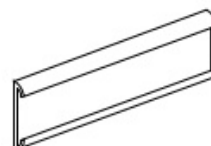

HD DRAWERS

ASSEMBLY INSTRUCTIONS

IMPORTANT

CHECK MATERIAL RECEIVED I.E. NUMBER OF PACKAGES AND CONTENTS OF EACH PACKAGE.
PLACE MATERIAL NEAR AREA TO BE INSTALLED.
READ ASSEMBLY INSTRUCTIONS BEFORE STARTING.



HD DRAWERS

1) Assemble Side and Back Panels

Bolt side panels to box posts and angle posts using 1/4" 20 by 1/2" bolts and 1/2" 20 nuts. Attach footplates using 1/4" 20 by 3/4" bolts and 1/2" 20 nuts. Bolt the back panel to the side panels using 1/4" 20 by 1/2" bolts and 1/2" 20 nuts. Keep the back panel on the outside of the angle posts, and double check that the panels' bolts/nuts are 26" from the footplates.



2A) Install Bottom Shelf and Drawer Glides

Place shelf clips in the bottom square of each angle and box post. Lay a shelf on these four clips such that it is roughly 3" off the floor. If this isn't the case, adjust the clips and reposition the shelf. Beginning with this shelf, insert the right glide by locking the back glide hook into the first square slot in an angle post. Fasten the front hook into the first square slot in a box post. Repeat this procedure for the left glide, then install all required pairs of glides spacing each 3" from the last.

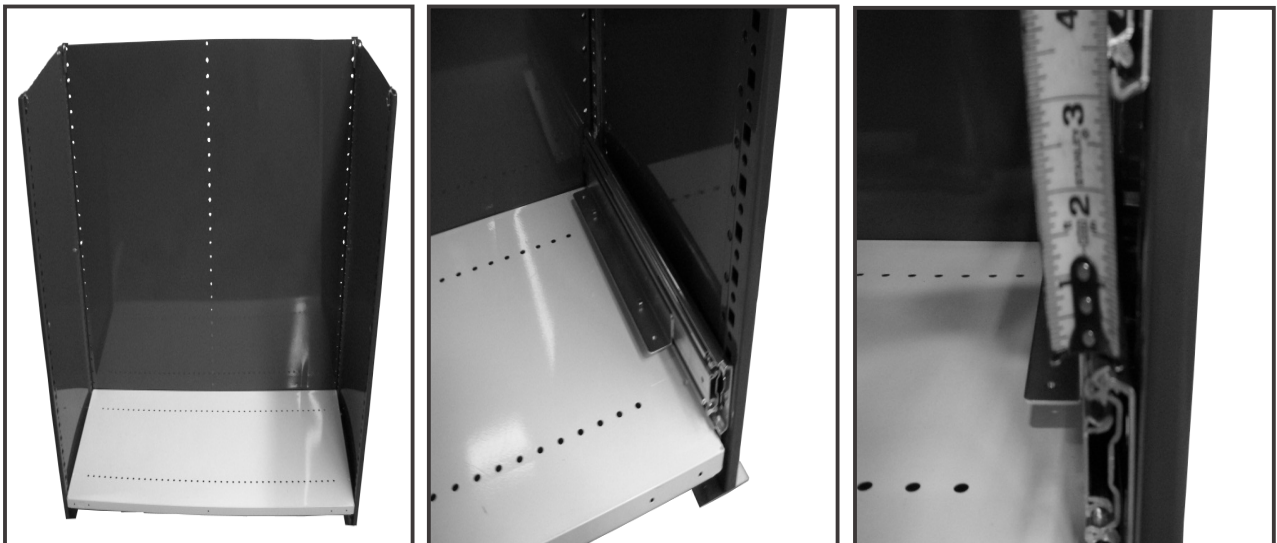

HD DRAWERS

2B) Install Drawer Glides for Combination Units

Follow Step 2A, but change the spacing from 3" to 4" if 3" drawers are directly above 6" drawers. If directly above another 3" drawer, change the spacing to 1".



3) Secure Glides

Position one drawer clip above each glide so that it is even with the holes in a box post. Use drawer bolts to attach the clips.

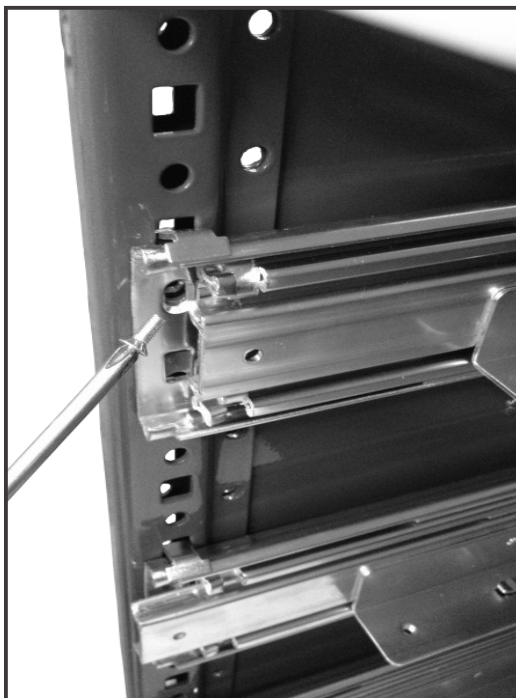

HD DRAWERS

4) Install Drawers

Fully extend the glides. Beginning at the top, situate the drawers one following the next. Work back upwards using drawer bolts to connect the base and the glides in both back corners of each drawer. Close each drawer after it's secure to bring the holes in the base and glide into alignment.

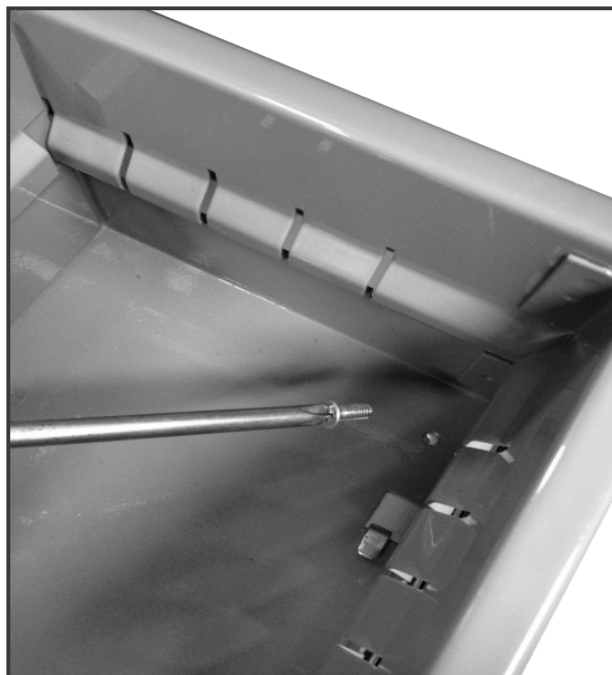
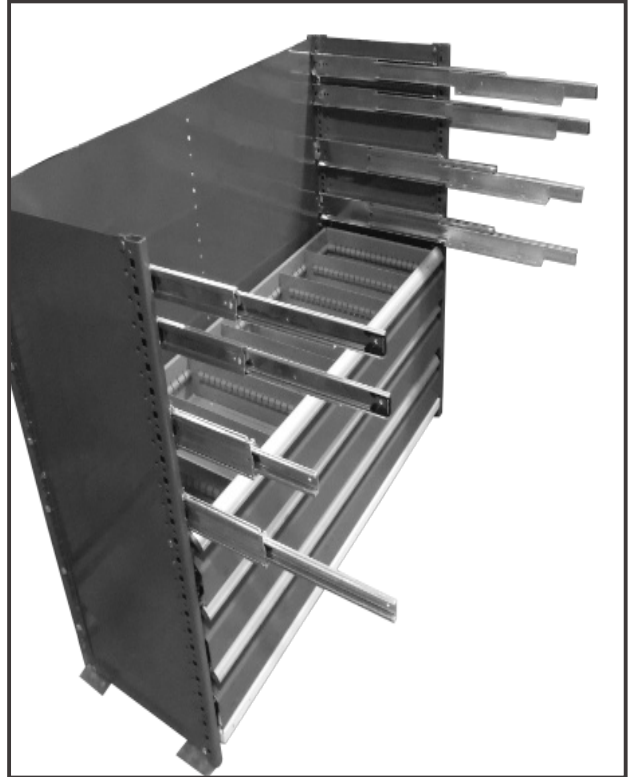
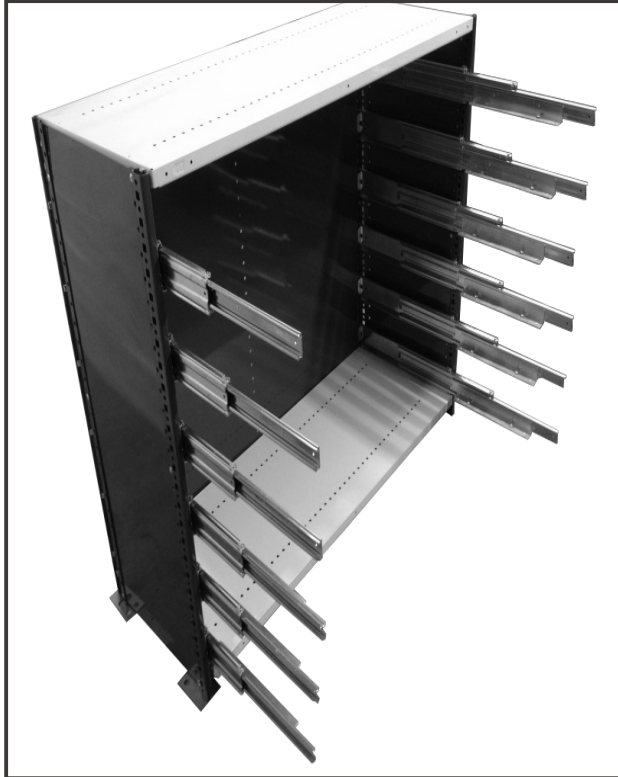

HD DRAWERS

5) Install Top Shelf and Complete Unit

If the top drawer is 6" tall, attach a shelf clip to both angle posts and half clip to both box posts. If the top drawer is only 3" tall, use half clips in all four corners. Attach the back panel to the side panels using 1/4" 20 by 1/2" 20 bolts and 1/2" 20 nuts. Keep the back panel on the outside of the angle posts, and double check that the panels' bolts/nuts are 26" from the footplates.



HD DRAWERS



HD DRAWERS

1) Assemble Side and Back Panels

Bolt side panels to box posts and angle posts using 1/4" 20 by 1/2" bolts and 1/2" 20 nuts. Attach footplates using 1/4" 20 by 3/4" bolts and 1/2" 20 nuts. Bolt the back panel to the side panels using 1/4" 20 by 1/2" bolts and 1/2" 20 nuts. Keep the back panel on the outside of the angle posts, and double check that the panels' bolts/nuts are 26" from the footplates.

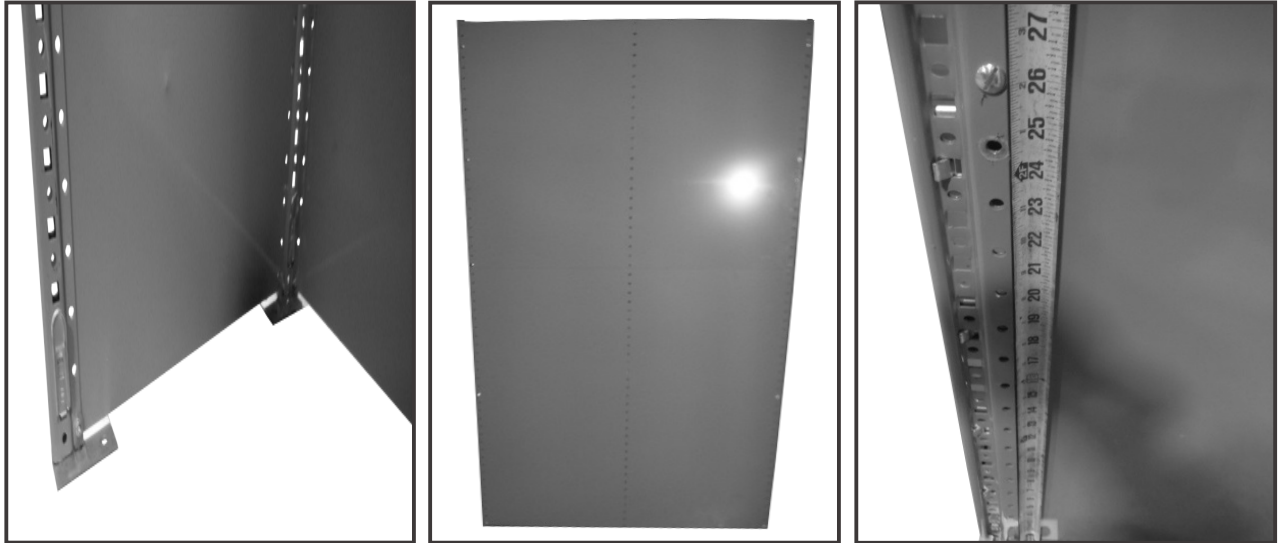

2A) Install Bottom Shelf and Drawer Glides

Place shelf clips in the bottom square of each angle and box post. Lay a shelf on these four clips such that it is roughly 3" off the floor. Adjust shelf clips if this is not the case. Beginning with this shelf, insert the right glide by locking the back glide hook into the first square slot in an angle post. Fasten the front hook into the first square slot in a box post. Repeat this procedure for the left glide, then install all required pairs of glides spacing each 3" from the last.

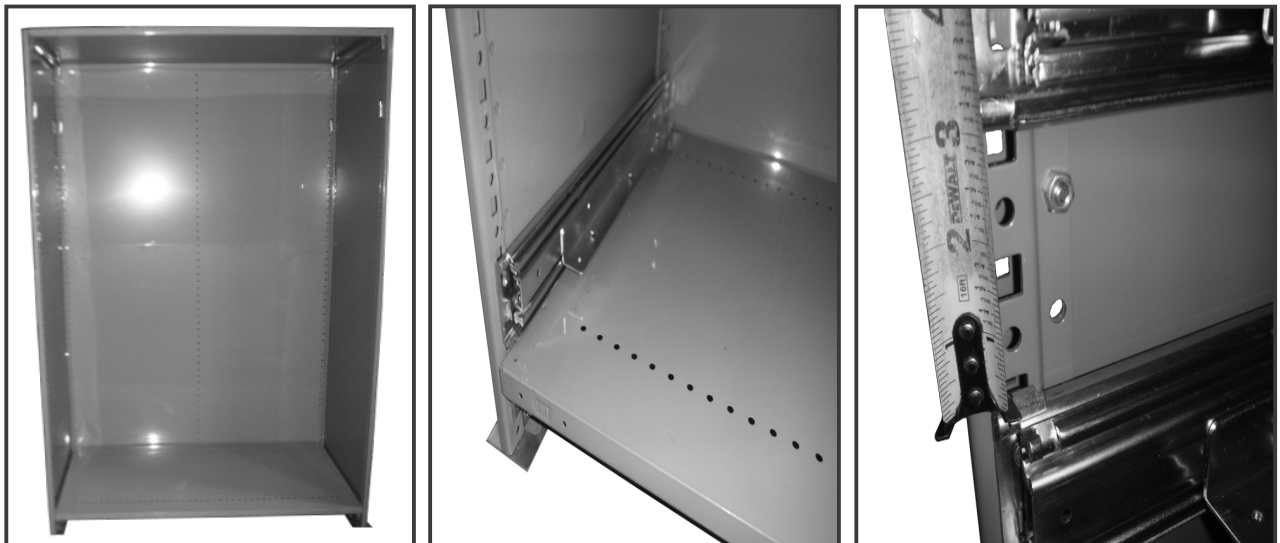

HD DRAWERS

2B) Install Drawer Glides for Combination Units

Follow Step 2A, but change the spacing from 3" to 4" if 3" drawers are directly above 6" drawers. If directly above another 3" drawer, change the spacing to 1".

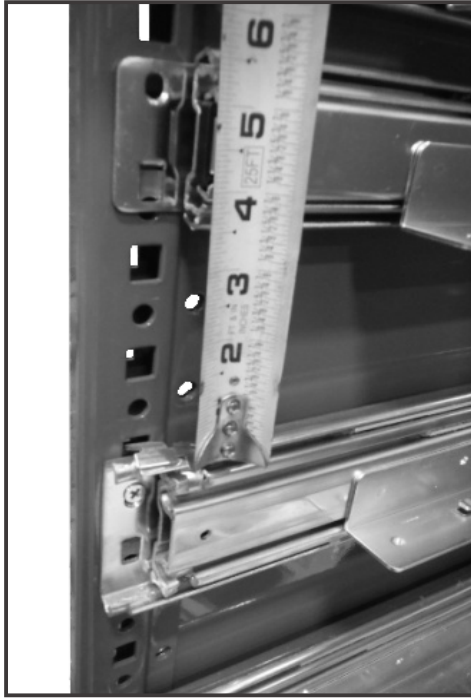

3) Secure Glides

Position one drawer clip above each glide so that it is even with the holes in a box post. Use drawer bolts to attach the clips.

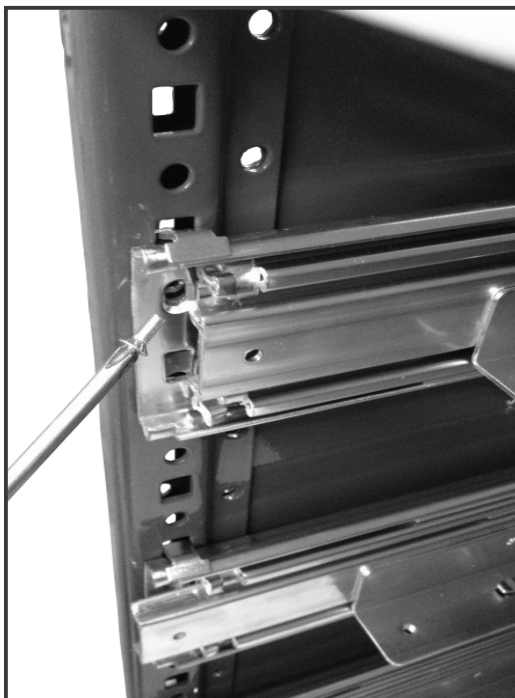

HD DRAWERS

4) Install Drawers

Fully extend the glides. Beginning at the top, situate the drawers one following the next. Work back upwards using drawer bolts to connect the base and the glides in all corners of each drawer. Close each drawer after it's secure to bring the holes in the base and glide into alignment.

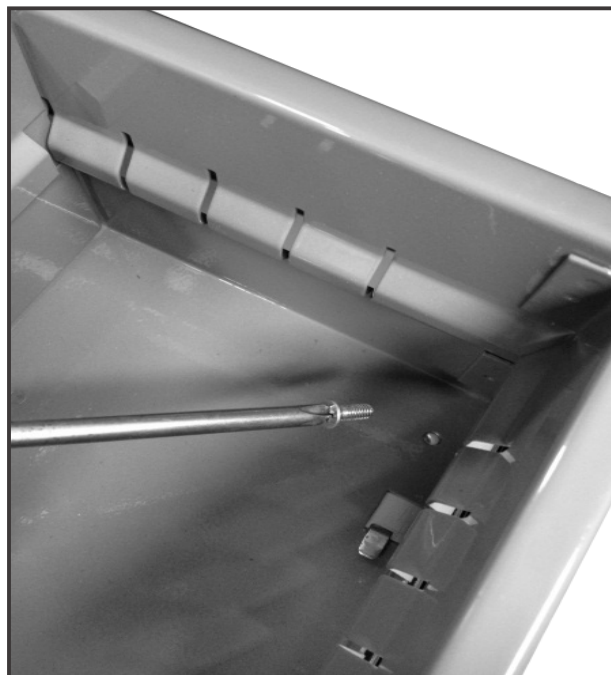
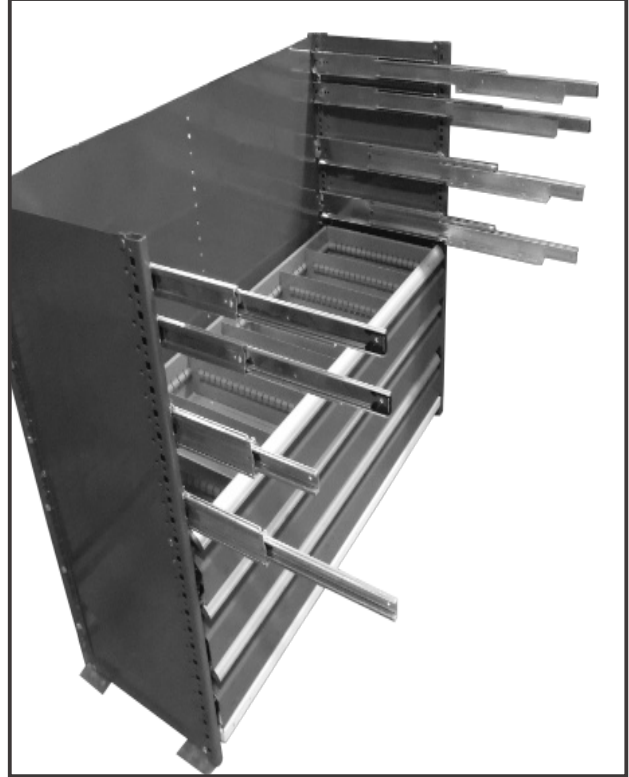

HD DRAWERS

5) Install Top Shelf and Complete Unit

If the top drawer is 6" tall, attach a shelf clip to both angle posts and half clip to both box posts. If the top drawer is only 3" tall, use half clips in all four corners. Attach the back panel to the side panels using 1/4" 20 by 1/2" 20 bolts and 1/2" 20 nuts. Keep the back panel on the outside of the angle posts, and double check that the panels' bolts/nuts are 26" from the footplates.

