

## SPECIFICATIONS KLIP-BILT II® SHELVING

**KLIP-BILT II®** shelving is industrial duty adjustable steel shelving constructed as a structurally independent unit consisting of posts, shelves, back and side “X” bracing, and/or back and side panels, and required hardware. A variety of accessories can be added to the basic unit to suit particular storage requirements. Standard nominal unit sizes are: 36”, 42”, or 48” wide by 12’, 18”, or 24” deep in heights of 3’-4”, 6’-1”, 7’-1”, or 8’-1”. Other sizes are available.

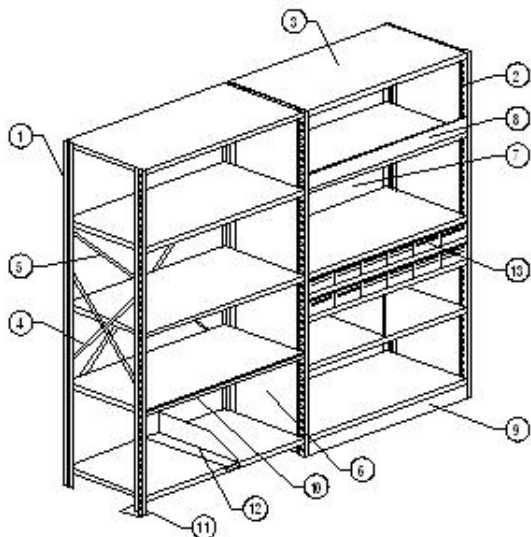

- 1 Angle Post
- 2 Box Post
- 3 Shelf
- 4 Side “X” Brace
- 5 Back “X” Brace
- 6 Side Panel
- 7 Back Panel
- 8 Bin Front
- 9 Base Front
- 10 Label Holder
- 11 Universal Footplate
- 12 Shelf Divider
- 13 Plastic-Bilt Drawer®

### SHELF CAPACITIES - EVENLY DISTRIBUTED NON-IMPACT LOADS (max. lbs/shelf)

SHELF SIZE	TYPE A	TYPE B
36” X 12”	600	800
36” X 18”	600	800
36” X 24”	600	850
42” X 24”	500	675
48” X 12”	400	500
48” X 18”	400	500
48” X 24”	400	525

### Component Parts

**OFFSET ANGLE POST** – 13 Ga. steel formed into an angle with a 1” front face has a channel shaped offset for added strength. Both flanges is punched with 5/16” holes on 1-1/2” center for attaching sway braces, back/side panels, and certain accessories. The 2-1/16” side flange is punch with 1/2” X 7/16” rectangular slots on 1-1/2” centers to accept shelf clip.

**STRONG BOX POST** – 13 Ga. steel formed into a tubular shape 3/4” wide X 2-1/16” deep. The 2-1/16” flanges is offset at the back on both sides to form a closed tubular shape and provide added strength. The 3/4” face to be free of punching and be flush with the front flange of the shelf. The 2-1/16” flange is punched with 5/16” holes on 1-1/2” centers for attaching sway braces, side panels, and certain accessories. The 2-1/16” side flanges is also punched with 1/2” X 7/16” rectangular slots on 1-1/2” center to accept shelf clips.

**SHELT – TYPE A** – 18 Ga. steel with all four sides flanged 1-1/8” at 90°. Front and back to have 9/16” return flange. Both sides to have 5/8” return flanges at 90°. Shelf corners to be closed, overlapped, and welded. Front and back flange is punched for attaching reinforcing bars, back panels, and certain accessories.

**SHELF – TYPE B** – same as Type A shelf except front and back flanges is reinforced with a flat bar, 11 Ga. X 15/16” wide. Bars may be crimped or bolted in place in the front and back shelf flanges.

# KLIP-BILT II® (Industrial Shelving)

## OFFSET ANGLE POST 13 Ga.

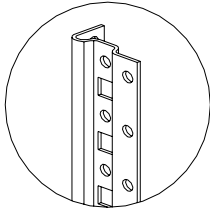

PART #	DESCRIPTION	WT.EA.
40040	OFFSET ANGLE POST 3'-4"	2.8
40021	OFFSET ANGLE POST 6'-1"	5.2
40027	OFFSET ANGLE POST 7'-1"	6.1
40033	OFFSET ANGLE POST 8'-1"	7.0
40045	OFFSET ANGLE POST 10'-1"	8.7
40057	OFFSET ANGLE POST 12'-1"	10.4
40075	OFFSET ANGLE POST 15'-1"	13.0
40099	OFFSET ANGLE POST 20'-1"	17.3

## STRONG BOX POST 13 Ga.

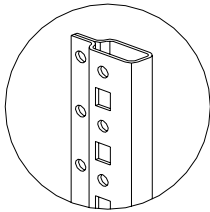

PART #	DESCRIPTION	WT.EA.
40104	STRONG BOX POST 3'-4"	4.3
40121	STRONG BOX POST 6'-1"	7.9
40127	STRONG BOX POST 7'-1"	9.2
40133	STRONG BOX POST 8'-1"	10.4
40145	STRONG BOX POST 10'-1"	13.0
40157	STRONG BOX POST 12'-1"	15.6
40175	STRONG BOX POST 15'-1"	19.5
40199	STRONG BOX POST 20'-1"	25.9

## FLAT BACK SWAY BRACE

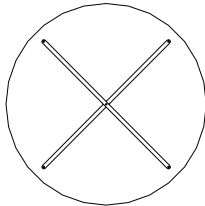

PART #	DESCRIPTION (Sold in pairs)	WT.EA.
44753	FLAT BACK X BRACE-36"	1.1
44754	FLAT BACK X BRACE-42"	1.3
44755	FLAT BACK X BRACE-48"	1.5

## SHELVING

18 Ga.

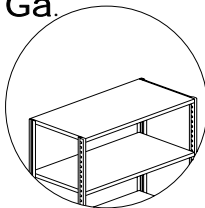

PART #	DESCRIPTION	WT.EA.
40269	SHELF-TYPE A – 36" X 12"	7.7
40271	SHELF-TYPE A – 36" X 18"	10.9
40272	SHELF-TYPE A – 36" X 24"	14.0
40280	SHELF-TYPE A – 42" X 24"	16.3
40285	SHELF-TYPE A – 48" X 12"	10.2
40287	SHELF-TYPE A – 48" X 18"	14.3
40288	SHELF-TYPE A – 48" X 24"	18.5

## BACK PANEL

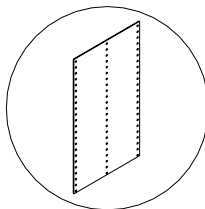

Panels 49" or higher are supplied as (2) or more pieces.

PART #	DESCRIPTION	WT.EA.
40604	BACK PANEL 36 X 3'-4"	9.6
40621	BACK PANEL 36 X 6'-1"	17.5
40627	BACK PANEL 36 X 7'-1"	20.4
40633	BACK PANEL 36 X 8'-1"	23.3
40639	BACK PANEL 36 X 9'-1"	26.2
40645	BACK PANEL 36 X 10'-1"	29.1
40671	BACK PANEL 42 X 6'-1"	20.5
40677	BACK PANEL 42 X 7'-1"	23.9
40683	BACK PANEL 42 X 8'-1"	27.3
40695	BACK PANEL 42 X 10'-1"	34.0
40704	BACK PANEL 48 X 3'-4"	12.8
40721	BACK PANEL 48 X 6'-1"	23.5
40727	BACK PANEL 48 X 7'-1"	27.3
40733	BACK PANEL 48 X 8'-1"	31.2
40745	BACK PANEL 48 X 10'-1"	38.9

PART #	DESCRIPTION	WT.EA.
43018	BASE FRONT 36 X 2-7/8	1.5
43019	BASE FRONT 42 X 2-7/8	1.7
43020	BASE FRONT 48 X 2-7/8	1.9

### BASE FRONT

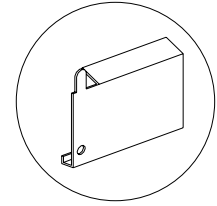

PART #	DESCRIPTION (Sold in pairs)	WT.EA.
43653	SIDE X SWAY BRACE-12"	0.3
43655	SIDE X SWAY BRACE-18"	0.5
43656	SIDE X SWAY BRACE-24"	0.7

### SIDE X SWAY

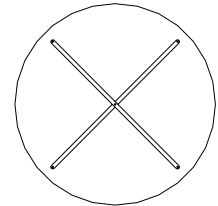

PART #	DESCRIPTION	WT.EA.
43142	BIN FRONT 36 X 3	2.3
43417	BIN FRONT 42 X 3	2.7
43152	BIN FRONT 48 X 3	3.1

### BIN FRONT

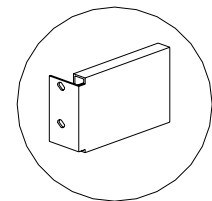

PART #	DESCRIPTION	WT.EA.
41104	SIDE PANEL 12 X 3'-4	2.4
41121	SIDE PANEL 12 X 6'-1	4.5
41127	SIDE PANEL 12 X 7'-1	5.2
41133	SIDE PANEL 12 X 8'-1	6.0
41145	SIDE PANEL 12 X 10'-1	7.4
41204	SIDE PANEL 18 X 3'-4	4.1
41221	SIDE PANEL 18 X 6'-1	7.4
41227	SIDE PANEL 18 X 7'-1	8.7
41233	SIDE PANEL 18 X 8'-1	9.9
41245	SIDE PANEL 18 X 10'-1	12.3
41254	SIDE PANEL 24 X 3'-4	5.7
41271	SIDE PANEL 24 X 6'-1	10.4
41277	SIDE PANEL 24 X 7'-1	12.1
41283	SIDE PANEL 24 X 8'-1	13.8
41295	SIDE PANEL 24 X 10'-1	17.2

### SIDE PANEL

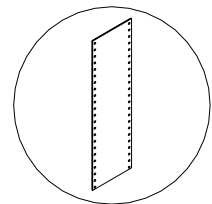

**Panels 49" or higher are supplied as (2) or more pieces.**

PART #	DESCRIPTION	WT.EA.
42256	SLIDING DIVIDER 24 X 6	2.0

### SLIDING DIVIDER

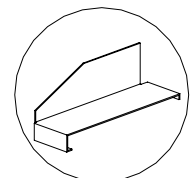

## FOOTPLATE

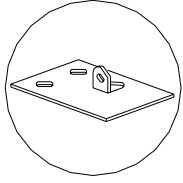

PART #	DESCRIPTION	WT.EA.
45402	FOOTPLATE	.3
45403	SHIM	.3

## LICKETY-KLIP®

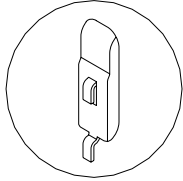

PART #	DESCRIPTION	WT.EA.
46252	LICKETY-KLIP	.1

## GUSSET BRACES

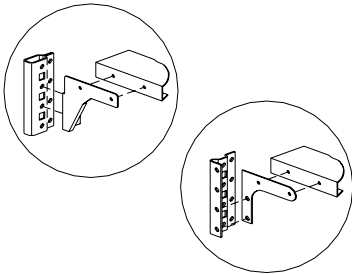

PART #	DESCRIPTION	WT.EA.
44020	OFFSET ANGLE POST	.1
44025	BOX POST (RH)	.3
44026	BOX POST (LH)	.3

## SPLICE BRACKETS

PART #	DESCRIPTION	WT.EA.
40100	STRONG BOX POST	.2
40101	ANGLE POST (BACK)	.3
40102	ANGLE POST (SIDE)	.4
40103	ANGLE POST (INTERMEDIATE)	.1

## MEZZANINE COMPONENTS

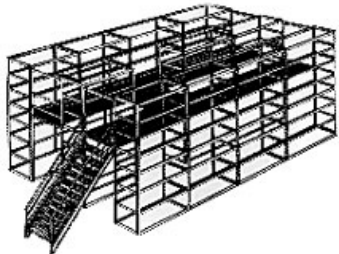

PART #	DESCRIPTION	WT.EA.
27006	FRONT POST BRACKET (RH)	.8
27007	FRONT POST BRACKET (LH)	.8
27012	END AISLE POST BRACKET (RH)	.8
27013	END AISLE POST BRACKET (LH)	.8
27040	CROSS AISLE SUPPORT CHANNEL 36"	5.8
27041	CROSS AISLE SUPPORT CHANNEL 42"	6.8
27042	CROSS AISLE SUPPORT CHANNEL 48"	7.8
27044	END AISLE SUPPORT CHANNEL 36"	5.8
27045	END AISLE SUPPORT CHANNEL 42"	6.8
27046	END AISLE SUPPORT CHANNEL 48"	7.8

# SHELVING

## Box Shelf 20 Ga.

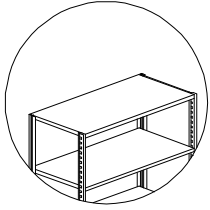

PART #	DESCRIPTION	WT.EA.
40369-20	BOX SHELF – 36" X 12"	7.6
40371-20	BOX SHELF– 36" X 18"	9.7
40372-20	BOX SHELF– 36" X 24"	12.4
40380-20	BOX SHELF– 42" X 24"	14.2
40385-20	BOX SHELF– 48" X 12"	10.2
40387-20	BOX SHELF– 48" X 18"	13.0
40388-20	BOX SHELF– 48" X 24"	16.2